

MULL(it)OVER

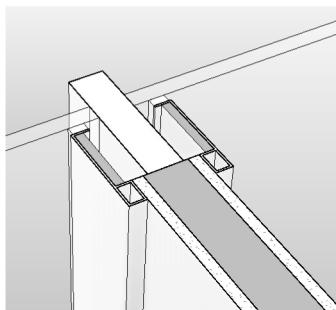
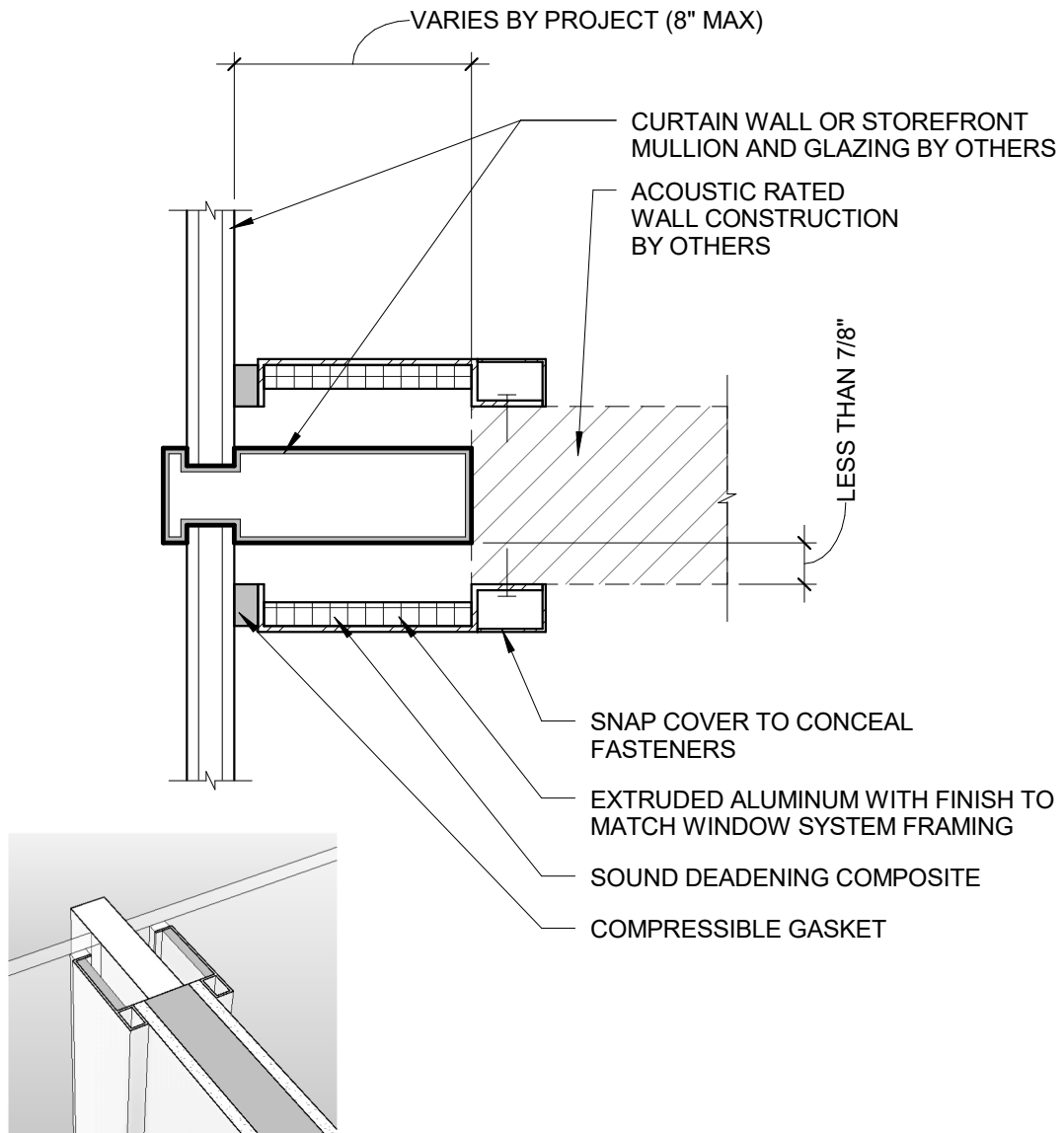

3D VIEW

60 FLUSH

SCALE: 3" = 1'-0"

MULL IT OVER PRODUCTS
(616) 730-2162

www.mullitoverproducts.com
info@mullitoverproducts.com

Patent No. 8,572,914 & 8,782,977